



SETTLING
WITHOUT
BORDERS

CSD DCP Workshops - 2014

Session VII
Testing and Migration

29th January 2014



SETTLING
WITHOUT
BORDERS

Agenda

Introduction

T2S User Testing

1. Status Update T2S User Testing Subgroup
 - a. T2S User Testing Plan
 - b. E2E-Volume Testing
 - c. DCP Certification and Authorization
2. Updates on Testing related Change Requests

T2S Migration

1. Status Update T2S Migration Subgroup
2. Updates on Migration related Change Requests

Miscellaneous

1. Firm DCP Commitment
2. Market Readiness Reporting

Workshop Overview & Timeline 2014

Currently three joint DCP CSD workshops are set-up for Q1-2014 which will continue the facilitation of workshops in 2013

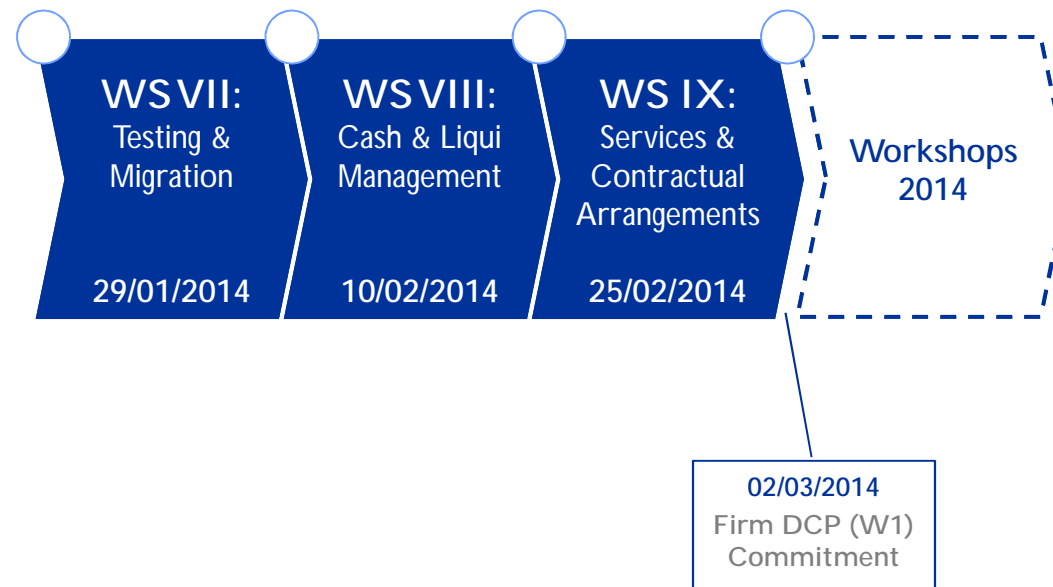

Objectives of today's Workshop



Situation

- § Two initial workshops on Testing and Migration have been conducted in 2013
- § Meanwhile progress within both subgroups has been achieved providing answers to open remained questions
- § Further questions arising from DCPs as their internal projects have been progressed as well



Objective

-
- § Provide an update on the latest developments relevant for DCPs regarding testing and migration
 - § Reach a common understanding on the status and potential customer impact of testing and migration related T2S Change Requests
 - § Discuss the topic of firm DCP Commitment and make a first step towards a common agreement regarding the process and its formalities
 - § Exchange views on DCP Readiness Reporting



SETTLING
WITHOUT
BORDERS

Agenda

Introduction

T2S User Testing

1. Status Update T2S User Testing Subgroup
 - a. T2S User Testing Plan
 - b. E2E-Volume Testing
 - c. DCP Certification and Authorization
2. Updates on Testing related Change Requests

T2S Migration

1. Status Update T2S Migration Subgroup
2. Updates on Migration related Change Requests

Miscellaneous

1. Firm DCP Commitment
2. Market Readiness Reporting

Status Update T2S User Testing

Update on major User Testing Sub-group deliverables

	2013	2014	Next delivery date
User Testing Terms of Reference (UT ToR)	<ul style="list-style-type: none"> – UT ToR Version 2.02 was approved by T2S Board in December 2013 	<ul style="list-style-type: none"> – A further update is planned for mid of 2014 	04/07/2014 (Update on Version 2.02)
High Level User Testing Calendar	<ul style="list-style-type: none"> – The test calendar details the test planning on a weekly basis 	<ul style="list-style-type: none"> – Currently cross-wave discussions are on-going 	Q1/2014 (Baseline Version)
User Testing Process Guide	<ul style="list-style-type: none"> – This document defines all testing related processes – Meanwhile a number of processes were agreed to be stable 	<ul style="list-style-type: none"> – Further updates / additions will be discussed and agreed on in the UTSG meetings – A final approval will follow after the single processes were agreed on 	30/07/2014 (Version 1.0)
Eurosystem Certification Test Cases	<ul style="list-style-type: none"> – T2S Certification test cases were approved by the T2S Board in December 2013 	<ul style="list-style-type: none"> – The detailed test cases will be provided at the end of March for CSDs / CBs and DCPs 	31/03/2014

Please note:

The UTSG also works on:

- User Testing Reporting Framework
- Test Data Segregation
- User Testing Registration Guide

Some topics depend on the progress of other sub-groups:

- Migration Test and Migration Contingency Test (dependency to MSG)
- Operational related Tests including Contingency Test (dependency to OMG)



SETTLING
WITHOUT
BORDERS

Agenda

Introduction

T2S User Testing

1. Status Update T2S User Testing Subgroup
 - a. T2S User Testing Plan
 - b. E2E-Volume Testing
 - c. DCP Certification and Authorization
2. Updates on Testing related Change Requests

T2S Migration

1. Status Update T2S Migration Subgroup
2. Updates on Migration related Change Requests

Miscellaneous

1. Firm DCP Commitment
2. Market Readiness Reporting

T2S User Testing Test Stages (Recap)

All user testing stages do apply for every testing phase of each wave

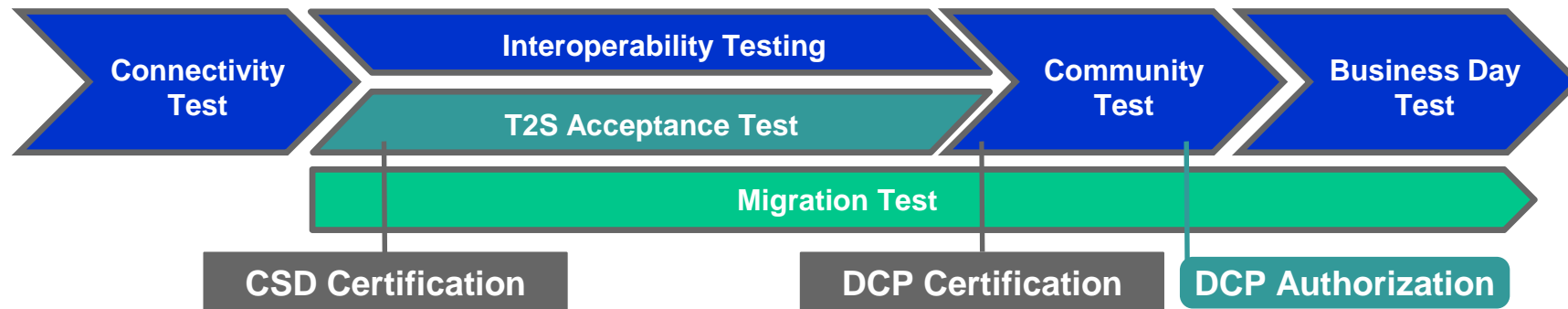

Connectivity Test

- § CSDs and NCBs establish T2S connectivity
- § Also in scope: exchange messages on application level, push and pull services for reports and access to the GUI
- § Note: Connectivity for DCPs will be established later, i.e. prior to Community Testing stage

Interoperability Test

- § **Bilateral I/O Test** - CSDs and NCBs test their interaction with T2S by using so-called "Mock Entities"
- § **Multilateral I/O Test** - One main focus is end-to-end testing of cross-border settlement links with involved CSDs

T2S Acceptance Test

- § Main objective is to ensure that the T2S platform meets the user requirements
- § Will cover both functional and non-functional testing

Community and Business Day Test

- § CSDs and NCBs test with their whole communities (DCPs and ICPs)
- § Focus is to verify the correct functioning of T2S under production-like conditions
- § Business Day testing is planned to run with a production-like daily schedule

Migration Test

- § Migration Testing for CSDs and NCBs is planned to be executed on a dedicated environment
- § For all customers (DCPs and ICPs) Migration Rehearsals are planned at the start of Community and / or Business Day Testing

Community Testing

Recap of scope and approach

Scope

- § DCP connectivity set-up and testing starts two to three months before community testing (only for the first time when acting as a DCP)
- § CSDs, Central Banks and their communities have to align their test cycles with each other in the Community testing stage
- § T2S Testing Day Schedules have been aligned with T2 Community¹⁾. T2 availability clarified
- § DCP community will be involved in tests of the relevant business continuity procedures as agreed between UTSG/PMG and OMG

Participants

- § T2S, NCBs, CSDs, DCPs and ICPs
- § The Eurosystem with the CSDs and Central Banks of a migration wave will decide in the User Testing Subgroup when the DCPs connectivity set-up and testing shall start
- § DCPs perform their functional testing and execute the Certification test cases to obtain certification

Approach

- § Community Test is mandatory for all DCPs
- § The test will be executed under “production-like” system entity and data configuration but with different timing (to be defined in the user testing calendar) and transactional data volumes
- § DCPs will receive pre-defined test cases to execute (certification and authorization)
- § This test phase is envisaged to start with an initial Pre-migration Migration Dress-Rehearsal and a Migration Weekend Rehearsal involving the customers (DCPs and ICPs)

1) Overview of T2S Test Schedules see page 16

Business Day Testing

Recap of scope and approach

Scope

- § In this stage the focus is to verify the correct functioning of T2S under production-like conditions
- § This specifically includes the so-called “live timing”, i.e. a production-like configuration and scheduling of all processes
- § The system will be operated and configured as in production
- § Business Day Test includes further testing of operational procedures, such as the testing of crisis/incident management and business continuity
- § Interaction with T2 Community¹⁾

Participants

- § T2S, NCBs, CSDs, DCPs and ICPs
- § The testing involves the security-maintaining entities and previously migrated CSDs and Central Banks with links to the migrating CSDs

Approach

- § Business Day test execution begins with a load of transactional data through either a Migration Weekend Rehearsal or a Migration Weekend Dress Rehearsal depending on the migration volumes
- § The Eurosystem, CSDs, Central Banks and their communities may further test operational procedures, such as the testing of business continuity process
- § Transition from Business Day Testing will be done by preparing input for the go-no-go decision to go live with T2S Participants

Current T2S User Testing Timeline

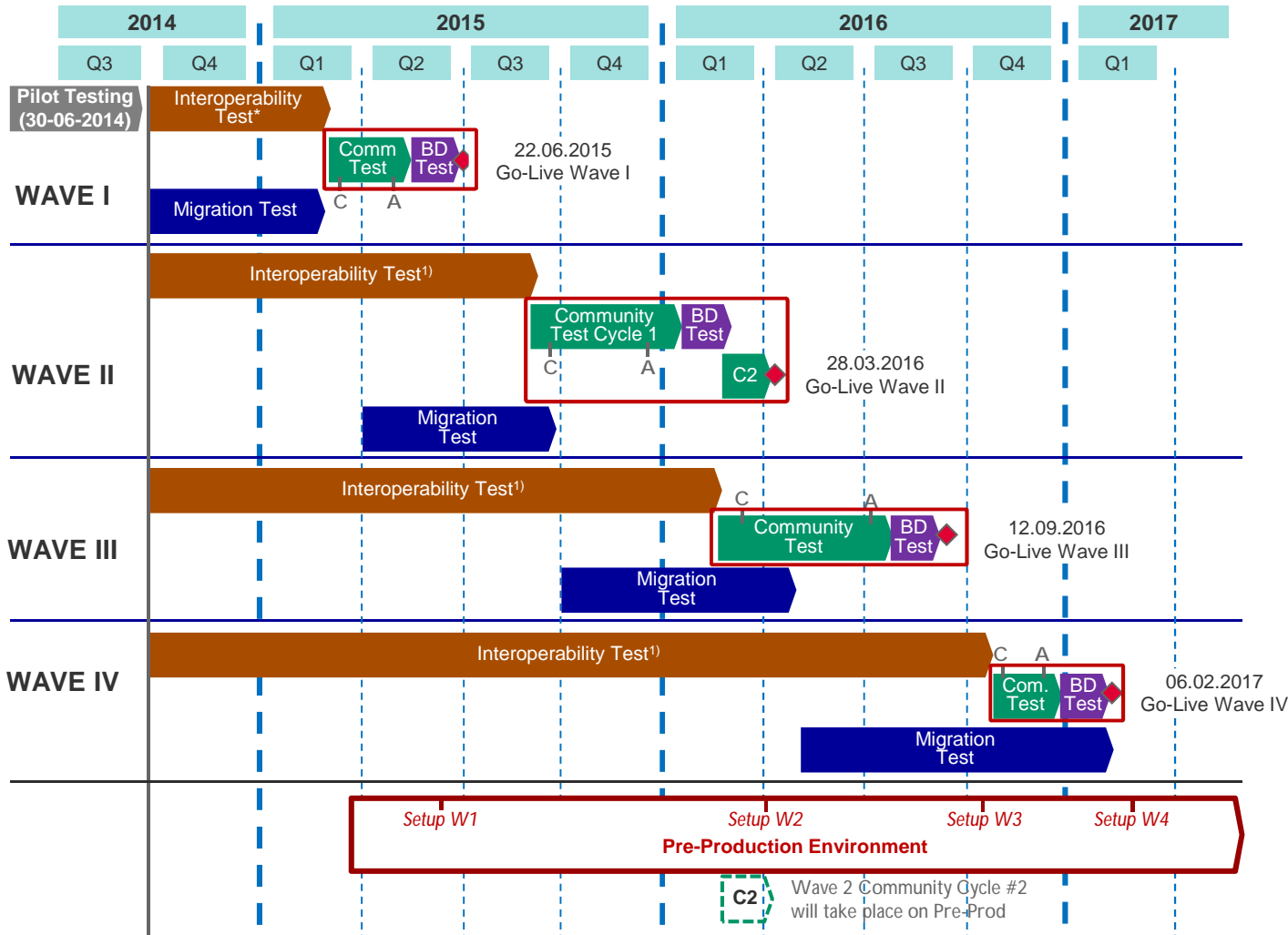

- According to the T2S Framework Agreement and the 'User Testing Terms of Reference' the community testing stage represents the first opportunity of the DCPs to start test interaction with T2S
- Start of Community resp. Business Day Test Stage with weekend (dress) rehearsal - involving also customers
- DCPs to plan their Eurosystem Certification testing during the first two (2) to four (4) weeks of the Community testing stage.
- DCP Authorization has to be passed during Community Testing stage for each wave where a DCP's CSD will migrate to T2S

SP 8

DCP/ICP involvement

Abbreviations:

- SP8 - Synchronisation Point 8: Start Bilateral Interoperability Testing
- BD Test: Business Day Test | A - DCP Authorisation | - C - DCP Certification

CSG
CSD Steering Group

1) CSDs will have a maximum of six months to accept T2S from the start of the Bilateral Interoperability testing stage (SP8); exception for wave 1 three months after start of SP8

T2S User Testing Phases Wave 1

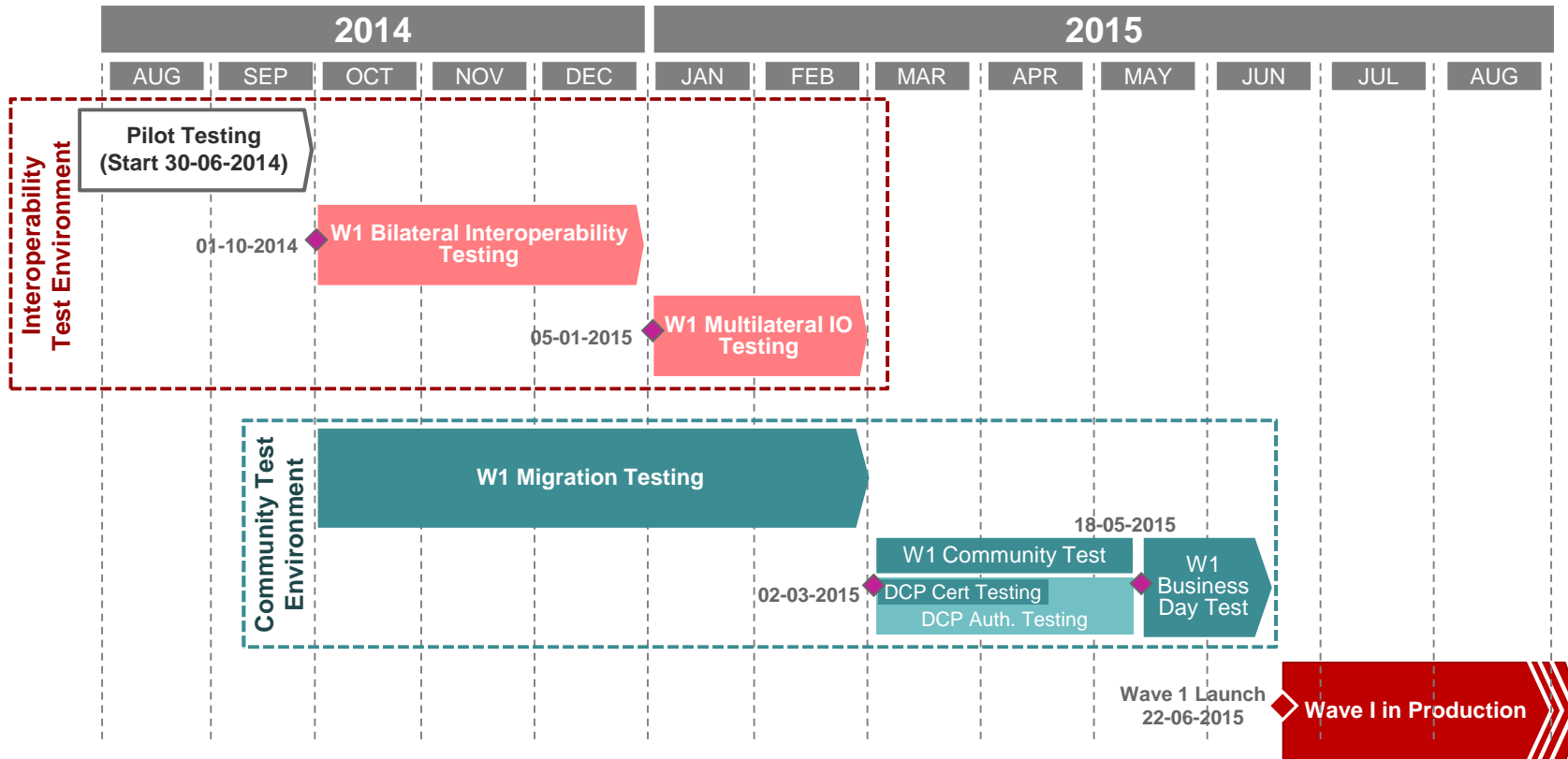

1) Example shows timing of community testing of wave 2 and 3; switch of wave 2 customer testing to pre-prod is current working assumption and has to be finally agreed in Q1/2014



SETTLING
WITHOUT
BORDERS

Community and Business Day Testing for Wave 1 Proposal provided by Wave 1- update

Involvement of DCP in later stages of migration testing has been discussed among wave1 actors and a general agreement on principles has been reached. These principles are:

- DCP need to complete connectivity set-up and test by end January 2015
- DCP involvement by one W1 actor will not have to create constraints to other W1 actors not testing with their DCPs
- Test calendar can change with short pre-advise should wave1 CSDs and CBs require that in order to achieve a smooth migration process as a wave.

In planning the last month of migration testing, wave1 agreed to:

- Include a number of days of business activity between migration tasks.
- Include a final pre-migration dress rehearsal as a safety measure to ensure that a consistent baseline can be prepared for Community testing. Should conditions allow, this task can be changed to include for different activity

General reminder: connection with T2 test environment not available during migration test

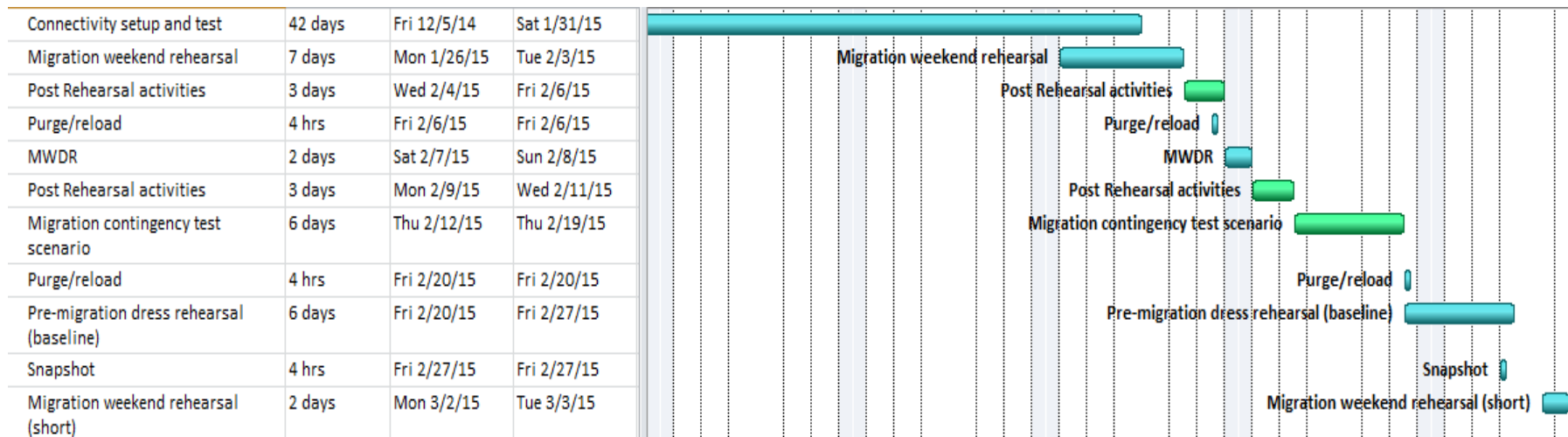

Community testing will include 3 migration weekend dress rehearsals will be executed with the whole community of W1 participants + SMEs

Community and Business Day Testing Approach Wave 2 & Wave 3¹⁾

The community testing stage provides the first opportunity of the DCPs to start test interaction with T2S

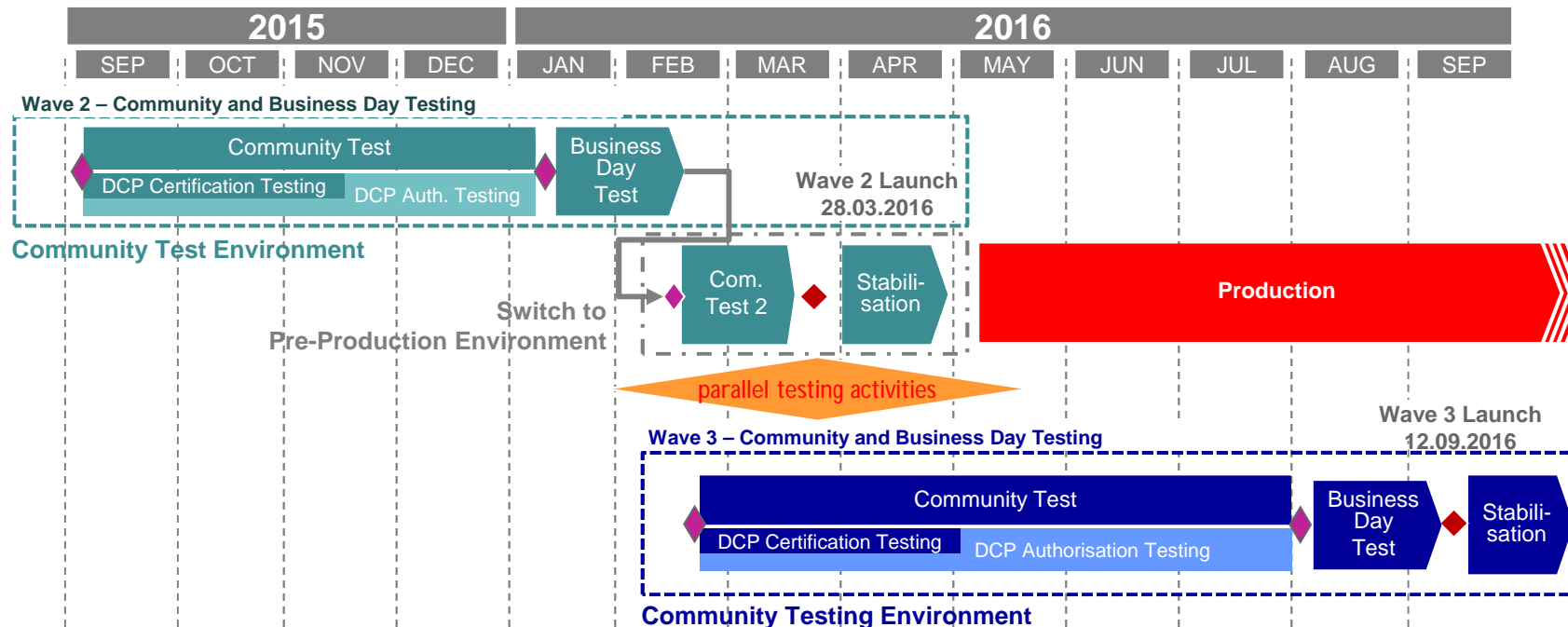

- § DCPs connecting to different CSDs in different migration waves have to establish parallel connectivity to multiple testing environments and will be faced with parallel testing activities during community and business day testing (applies to W2 & W3 only)
- § The herein described approach to continue the Community Testing of Wave 2 on the Pre-Production environment has been agreed among the CSD participants of wave 2 and wave 3 and represents the current working assumption of the UTSG
- § This approach provides sufficient testing time for wave 2 and wave 3

1) Timing of community testing of wave 2 and 3; switch of wave 2 customer testing to pre-prod is current working assumption and has to be finally agreed in Q1/2014

Details on User Testing Test Calendar

A baseline version is planned to be provided by March 2014

Status

- The test calendar translates the principles of the User Testing Terms of Reference into a more detailed plan (on a weekly basis, including weekends)
- During the last meetings a first version of the consolidated calendar for all waves was discussed and inconsistencies were discovered and / or resolved
- Main testing activities currently planned to be conducted on weekends are Migration Weekend (Dress) Rehearsals and End-to-End Volume Tests (for CSDs)

Potential Customer Impact

- Depending on the involvement on the actual migration weekend, the Migration Weekend Dress Rehearsals are of importance – specifically for customers acting in DCP mode

Next Steps

- A baseline version of the User Testing Test Calendar is planned to be provided by 31 March 2014
- All changes after end of March 2014 must follow a formal process, i.e. it will be much more difficult that ECB will agree to implement changes

TARGET2 and T2S daily schedules

T2S Daily Schedule ¹⁾	T2S Standard Day	T2S Synchronised Standard Day	T2S Release Day (every Friday) ²⁾	T2S Live Timing
Start of Testing	7:00	7:00	7:00	7:00
Real-time Settlement				
FoP Cut-off	17:00	15:30	15:30	18:00
End of Day / Start of Day				
Start of Night-time Settlement	18:30	17:00	17:00	19:30
Night-time Settlement				
End of Testing	19:00	19:00	17:30	~22:30

- § From October 2014 onwards the TARGET2 and T2S schedules will be aligned
- § The agreement was reached that the T2S Release Day schedule will be applied on every Friday (instead of on Release Days only)
- § T2S Live Timing is planned to be applied only during the Business Day testing stage
- § The User Test Calendar will define in detail when which test environment will be operated with which daily schedule

1) T2 daily schedule for Monday till Thursday has been adapted on November 18, 2013. The T2 schedule for Fridays will be adapted on July 1, 2014
 2) It must be noted that the T2S Release Day schedule will also be applied on other week days where an extraordinary software roll-out takes place



SETTLING
WITHOUT
BORDERS

Agenda

Introduction

T2S User Testing

1. Status Update T2S User Testing Subgroup
 - a. T2S User Testing Calendar
 - b. E2E-Volume Testing
 - c. DCP Certification and Authorization
2. Updates on Testing related Change Requests

T2S Migration

1. Status Update T2S Migration Subgroup
2. Updates on Migration related Change Requests

Miscellaneous

1. Firm DCP Commitment
2. Market Readiness Reporting

Community Testing Volumes restrictions

- Members of the DCP Forum would like to participate in End-to-End volume testing for wave 1, 2 or 3
- For further discussions, DCPs are invited to share their specific expectations and objectives for their participation in End-to-End volume testing
- The following dependencies need to be considered:
 - End-to-End volume testing takes place parallel to Community Testing
 - Capacity is limited by the Community Testing environment
 - The timing is limited to 5 testing weekends only



SETTLING
WITHOUT
BORDERS

Agenda

Introduction

T2S User Testing

1. Status Update T2S User Testing Subgroup
 - a. T2S User Testing Calendar
 - b. E2E-Volume Testing
 - c. DCP Certification and Authorization
2. Updates on Testing related Change Requests

T2S Migration

1. Status Update T2S Migration Subgroup
2. Updates on Migration related Change Requests

Miscellaneous

1. Firm DCP Commitment
2. Market Readiness Reporting

DCP Certification and Authorization

DCPs need to pass two steps which are very different to each other with regard to their objectives and comprehensiveness.

DCP Certification	DCP Authorization
<ul style="list-style-type: none"> § According to the Framework Agreement, the DCP Certification aims to provide evidence that the adapted IT platforms of a DCP does not harm T2S as the result of inappropriate technical communication or procedures. § As this is a ECB requirement, ECB will define the test cases which need to be successfully executed (test cases will be available 6 months before the community testing stage for wave 1). § The DCP Certification needs to be passed at an early stage of Community Testing. § The DCP Certification is less comprehensive than the DCP Authorization. § The DCP Certification has only to be passed once by a DCP, also when the DCP plans to connect to multiple CSDs. 	<ul style="list-style-type: none"> § The CSDs are responsible for the authorization and therefore define the test cases that a DCP needs to successfully execute to show its compliance with CSD's processing according to market and legal specific requirements. § The test cases will cover specific business processes including market and CSD specific requirements (e.g. domestic settlement, cross-border scenarios with In-CSD and Out-CSD). CSDs will individually provide the test cases in adequate time. § DCP Authorization needs to be successfully passed by the DCP for each of its CSDs prior to the end of the Community Test stage. § The CSDs aim to achieve a high degree of standardization. However, the degree of standardization depends on market and legal specific characteristics.

Note: Specific test cases can be subject to both, DCP Certification and DCP Authorization. If a test case has been already passed in the DCP Certification it serves as a proof for the DCP Authorization.

CSD and Securities DCP Certification (1/2)

ECB Certification test cases were approved by the T2S Board

Test ID	Connect. mode	Test case name	Relevant for		
			DCP Securities	SME CSD	CSD ¹⁾
CERT_01	A2A	Send a request to create a Security (file and / or single message)	-	M	M
CERT_02	A2A	Send a request to create a Party (file and / or single message)	-	-	M
CERT_03	A2A	Send a DVP Settlement Instruction (file and / or single message)	M	-	M
CERT_04	A2A	Send a FOP Settlement Instruction (file and / or single message)	M	-	M
CERT_05	A2A	Send two DVP linked Settlement Instructions (file and / or single messages)	O	-	O
CERT_06	A2A	Send a Settlement Restriction (file and / or single message)	O	-	O
CERT_07	A2A	Receive a report (in push mode and / or pull mode)	M	M	M

Source: ECB Certification Testing Test Cases (Version 1.0 07/11/2013) – Certification Testing was approved by T2S Board in December 2013

1) The CSD in its full role

Legend M : Mandatory

O : Optional depending on whether the T2S Actor will use the functionality in production

- : not applicable

CSD and Securities DCP Certification (2/2)

ECB Certification test cases were approved by the T2S Board

Test ID	Connect. mode	Test case name	Relevant for		
			DCP Securities	SME CSD	CSD ¹⁾
CERT_08	U2A	Create a Security	-	M	M
CERT_09	U2A	Create a Market-Specific Attribute	-	-	O
CERT_10	U2A	Create a Restriction Type	-	-	O
CERT_11	U2A	Enter a DVP Settlement Instruction	M	-	M
CERT_12	U2A	Display a report	M	M	M

Source: ECB Certification Testing Test Cases (Version 1.0 07/11/2013) – Certification Testing was approved by T2S Board in December 2013

1) The CSD in its full role

Legend M : Mandatory

O : Optional depending on whether the T2S Actor will use the functionality in production

- : not applicable

Cash DCP Certification

Certification Test cases were approved by T2S board

Test ID	Connect. mode	Test case name	Relevant for		
			Directly Connected DCA Holder	Central Bank Liquidity Provider	Central Bank Collateral Manager
CERT_02	A2A	Send a request to create a Party (file and/or single message)	-	M	M
CERT_13	A2A	Send a request for an Immediate Outbound Liquidity Transfer (file and/or single message)	M	M	M
CERT_14	A2A	Send a request for defining a Security as eligible for collateralisation (file and/or single message)	O	-	M
CERT_15	A2A	Send a Security Valuation Creation	O	-	M
CERT_07	A2A	Receive a report (in push mode and/or pull mode)	M	M	M
CERT_16	U2A	Create an External RTGS Account	-	M	M
CERT_17	U2A	Enter an Immediate Outbound Liquidity Transfer	M	M	M
CERT_12	U2A	Display a report	M	M	M

Source: ECB Certification Testing Test Cases (Version 1.0 07/11/2013) – Certification Testing was approved by T2S Board in December 2013

Legend M : Mandatory
O : Optional depending on whether the T2S Actor will use the functionality in production
- : not applicable

Harmonization Potential of DCP Testing Activities

	DCP Certification	DCP Authorization	Free Testing
Status	Test cases are defined by ECB and will be identical for every DCP	Test cases depend on individual business and market specifics	Test cases can be harmonized among CSDs (e.g. Syntax test)
Degree of Harmonization	High	Low	Medium



SETTLING
WITHOUT
BORDERS

Agenda

Introduction

T2S User Testing

1. Status Update T2S User Testing Subgroup
 - a. T2S User Testing Calendar
 - b. E2E-Volume Testing
 - c. DCP Certification and Authorization
2. Updates on Testing related Change Requests

T2S Migration

1. Status Update T2S Migration Subgroup
2. Updates on Migration related Change Requests

Miscellaneous

1. Firm DCP Commitment
2. Market Readiness Reporting

Testing related T2S Change Requests

Background for topics related to test and migration items

Most Change Requests (CRs) have been raised by the Migration Sub-group (MSG) and submitted to the Change Request Group (CRG). However, not all CRs have been assessed / accepted by the CRG

ECB ID ¹⁾	Criticality ²⁾	CR Title	Status	Potential customer impact
T2S 444 URD	High	User authentication without USB-token / SmartCard for GUI-access	CR on hold since 16.12. 2013	Yes

- Topic was raised by the German NUG and qualified as showstopper by some NUG members
- Change Request was set on hold in CRG on 16 December 2013
- Customers acting in DCP mode are requested to check if their IT infrastructure is compatible with the usage of USB-token / SmartCard solution

1) Details can be found in the ECB CRG documentation <http://www.ecb.europa.eu/paym/t2s/governance/tg/html/crg.en.html>

2) Criticality according to the ECB Change Request legal / business importance parameter,

T2S project issue: Missing provision check omnibus accounts

Issue Description

- § According to URD, T2S will ensure sufficient provision on the Issuer CSD omnibus account
- § ECB has informed that this functionality has not been implemented and proposed 3 different options to cope with that issue
- § The CRG has analysed the options and presented its preference to the CSG

Resolution

- § The CSG has resolved to implement the provision check according to the URD
- § There was agreement amongst CSDs that this was not the ultimate solution, however, CSDs acknowledged that they have to use the Change Management procedure in order to initiate further functional enhancements
- § The T2S Board afterwards has agreed to the resolution and envisaged March 2015 as delivery date

Next steps

- § Detailed information about affected modules and test areas have been requested
- § CSDs will conduct impact analysis about late functional delivery

Questions from DCP Forum (1/2)

Questions regarding Testing

1. Is the start of DCP testing activities dependent upon the signing of DCP-specific contracts?
2. General timeline for Certification and authorization tests, detailed plans to be distributed as currently stand in the UTSG and MSG working groups.
3. Community Testing is only 3 months, possibly extended to 4 months (from 15/02/2015). Need information on the detailed planning around testing timeline for MW1 (and also for the other migration waves).
4. DCP's Logistical planning during "Community Testing" (work with the CSD's & agree exactly what asset lines / positions / cash need to be migrated to facilitate DCP testing).
5. DCP's Volumes for testing: there will be some limitations as each of the CSD's have to manage their own volumes including their DCP's.
6. Definition of end-to-end testing (and migration procedures) does this include also trading venues and CCPs? Detailed planning required.

Questions from DCP Forum (2/2)

Questions regarding Testing

7. Community & Business Day testing approach, waves II + III (slide presented in Workshop 4): -this slide was slightly incorrect re the descriptions around pre-production; updated slide to be redistributed.
8. Differences in DCP vs ICP testing, question on what exactly those differences are in terms of:
 - Timing: Exact start date of testing of DCP's vs ICP's, and can that be made clear in the planning of each wave. As stated in the slides, "DCP connectivity set-up and testing starts two to three months before community testing (only for the first time when acting as a DCP) – see also item 2 above.
 - Scope: What exactly is the difference in terms of scope of testing. The whole connectivity/synchronization/ISO 20022 element falls away, and that should be a bigger part than just 5 %.

General

14. Will CSD's make available to DCP's a list of counterparty BIC's in T2S?
15. Will CSD's make available to DCP's a list of T2S accounts?
16. Contingency arrangements of a 6 months notification period for a switch between VAN providers (FWA) is deemed as too long, follow-up in OMG.



SETTLING
WITHOUT
BORDERS

Agenda

Introduction

T2S User Testing

1. Status Update T2S User Testing Subgroup
 - a. T2S User Testing Calendar
 - b. E2E-Volume Testing
 - c. DCP Certification and Authorization
2. Updates on Testing related Change Requests

T2S Migration

1. Status Update T2S Migration Subgroup
2. Updates on Migration related Change Requests

Miscellaneous

1. Firm DCP Commitment
2. Market Readiness Reporting

Update on major Migration Sub-group deliverables

Deliverables	Description	Next delivery date
Migration Strategy	The scope of this document is to present the migration approach that will be used to prepare and conduct the migration in T2S. This document covers the framework applicable for the migration, the roles and responsibilities of the parties involved and the activities to be performed to prepare, execute and monitor the migration process.	Released
Detailed Migration Storyline	The objective of this document is to provide a description of all generic activities, deadlines and procedures according to which all relevant T2S Actors will migrate to T2S, covering the period from 3 months before the migration weekend until the end of the stabilization period.	H1/2014 (Version 1.0)
Migration Toolkit Requirements and Specifications	The objective of this document is to provide the requirements needed for the development of the additional supporting tools and reports/queries that are required to support the migration (during the pre-migration period as well as during the migration weekend of the various migration waves). This document will be provided in addition to the Data Migration Tool Requirements and Related Procedures.	H1/2014 (Version 1.0)
Migration Weekend Playbook (wave specific)	The scope of this document is to provide the T2S Actors with the required information to execute the tasks requested for the preparation and execution of the T2S migration weekend. Tasks detailing the migration phase (detailed migration sequence of activities and organisation) are covered. More precisely, this document covers the schedule, the roles and responsibilities, and the identification of the success factors. The document is prepared / produced for each wave and takes into account the lessons learnt from the migration of the previous wave.	W1: H2/2014 (Version 2.0) W2: H2/2014 W3: H2/2014 W4: H2/2014 (Version 1.0)
Migration Communication Framework	The objective of this document is to define the information and communication flows required by the different migration actors to ensure successful migration preparation and execution.	H1/2014 (Version 1.0)
Migration Contingency Procedures	This document covers the escalation process and the operational procedures to be respected in case a contingency situation occurs during the Migration. It covers both the pre-migration period and the migration weekend.	H1/2014 (Version 1.0)

Source: Objectives of Migration Deliverables and Assumptions, Status Update and way forward - 13th Migration Sub-Group meeting" (21/22 January 2014)
As soon as the Eurosystem approves the documents, the documents will be made available on the DCP Forum website (<https://t2scsg.deutsche-boerse.com>).

T2S Migration period of each single wave is organised in four phases

Principally, the migration phase for each wave is divided into a connectivity phase, pre-migration period, the migration weekend itself and a subsequent stabilization phase

- § T2S Migration period starts with SP14.1 'Wave 1 ready to connect to production' (27/02/2015) and finishes with the end of stabilization period of wave 4 (w4 go-live 06/02/2017)¹
- § With pre-migration phase of Wave 1, CSDs are able to start to maintain securities reference data (in their role as SME)

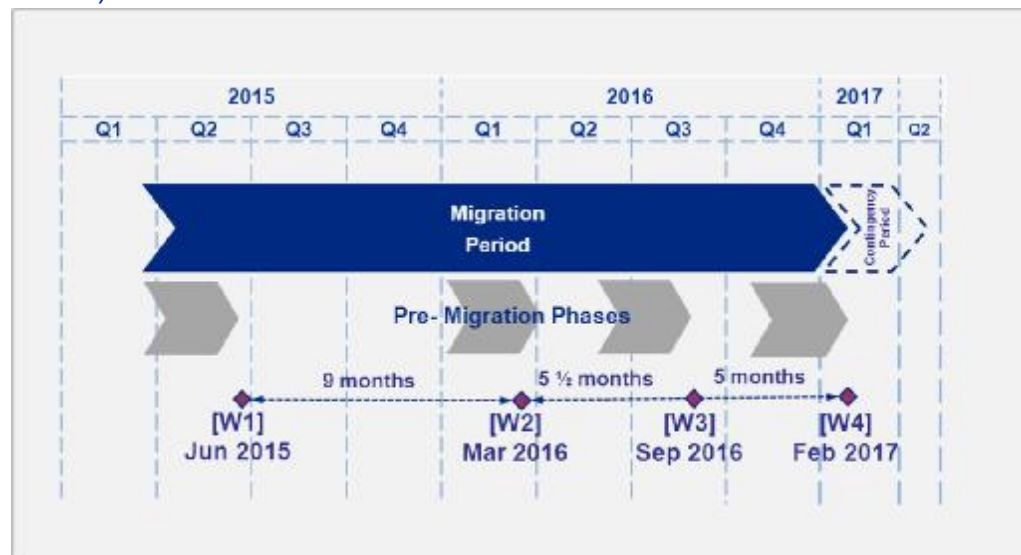

Based on current knowledge, DCPs can decide according to their own risk assessment to migrate either simultaneous with the respective CSD on the wave specific cut-over weekend, or at any point in time afterwards, except during a stabilisation period (maximum 4 weeks after a cut-over weekend). To provide DCPs utmost flexibility to migrate, a migration independent of the migration of the respective CSD can be subject to bilateral agreement.

¹⁾ assuming no contingency wave is required

Migration Organisation

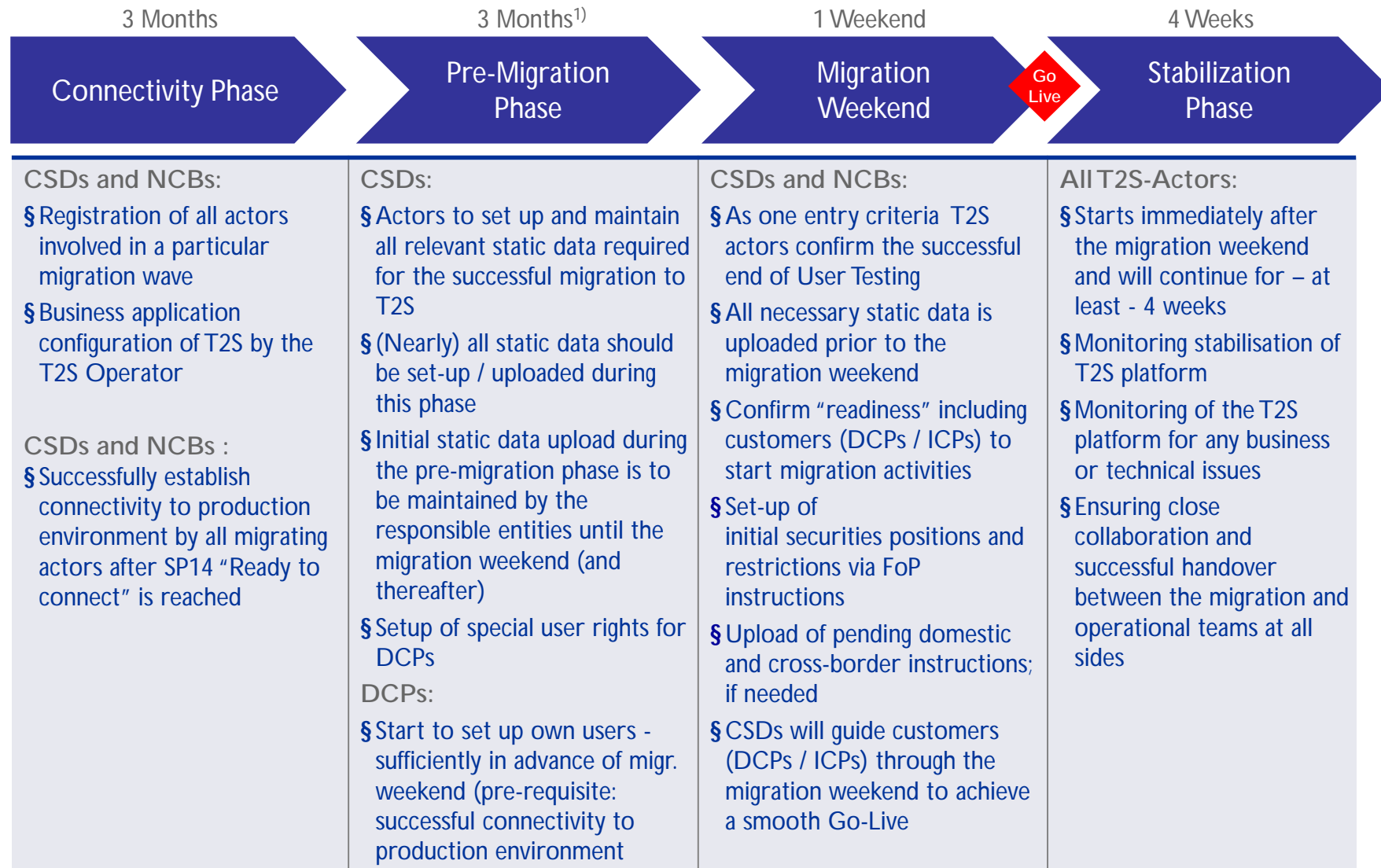

¹⁾ Duration of 3 months in general. Up to 4,5 months for wave 3 envisaged

Schedule of Migration Weekend

T2S Migration Weekend Playback

Block 1: Set up of initial securities positions

- FoP instructions upload
- Reconciliation of the uploaded data after T2S feedback
- Settlement of FoP Instructions (and restrictions)
- Reconciliation of settlement feedback

Block 2: Migration of pending instructions

- Upload of pending instructions
- Reconciliation of the uploaded data after T2S feedback

Block 3: Migration of new and maintenance instructions

- Upload of new instructions and maintenance instructions
- Reconciliation of the uploaded data after the T2S feedback

Block 4: Night-time settlement (NTS)

- First night-time settlement cycle
- Second night-time settlement cycle

- The migration weekend timeline is not yet completed due to the fact that some activities and/or timings are still missing (e.g. some data savings, repair activities)
- DCP involvement latest with point of no return¹⁾ (i.e. first time DCPs can interact with T2S during the migration weekend)
- DCPs will be involved during pre-migration activities prior to the cut-over weekend (e.g. send queries; quality check on static data)
- During cut-over weekend DCP activities will focus on changing their legacy platform and reconciliation towards the new/adapted CSD and T2S connectivity

Point of no return
Firm working assumption

1) with regards to cut-over weekend from T2S platform perspective



SETTLING
WITHOUT
BORDERS

T2S Migration Activities – Weekend Potential Customer Activities

Activities and dependencies between T2S Actors are covered in the detailed migration storyline

Technical Launches on Customer Side

- § In-house systems of the DCPs need to be updated over the migration weekend
- § Provide technical connectivity to T2S and CSD system infrastructure

Migration of Positions

- Different procedures among the CSDs for setting up the initial T2S positions might apply
- Some of the processing steps will be subject to customer reporting

Migration of Instructions

- § Prior to the migration weekend some organisational and / or technical measures may become necessary to reduce the number of pending instructions
- § The majority of instructions is expected to be migrated automatically by the CSD
- § For some instruction types it may be required to execute a cancellation / re-instruct procedure (e.g. due to differences in the transaction life cycle models). This approach is applicable to all pending cross-border instructions with involvement of migrating CSDs (affecting also already migrated CSDs)
- § Pending instructions with an intended settlement date before Go-Live and older than the initial set up date of the CSD entity in T2S will be treated in the same way as any other pending instruction (a possible solution has been agreed meanwhile and was described in a related change request¹⁾)

Messaging during Migration Weekend

- § Customers acting in DCP mode will receive their messages after the verification of the CSDs
- § Messages will be provided after the “Point of No Return” has been achieved
- § Such messages, queries or reports cannot be processed by the customers “business as usual” - processes and require special treatment
- § Messages send by a DCP on the migration weekend will be rejected by T2S (messages to be resend)²⁾

Filtering of instructions

- § It was agreed that T2S will not suppress / filter out any messages to DCPs
- § DCPs to take appropriate measures to suppress / filter the relevant messages
- § Only a blocking of messages until a certain point of time will be supported by T2S

1) Change Request #T2S-0409 SYS “Migration of Pending instructions with ISD in the past”
2) Change Request #T2S-0431 SYS “Queuing of incoming messages”



SETTLING
WITHOUT
BORDERS

Agenda

Introduction

T2S User Testing

1. Status Update T2S User Testing Subgroup
 - a. T2S User Testing Calendar
 - b. E2E-Volume Testing
 - c. DCP Certification and Authorization
2. Updates on Testing related Change Requests

T2S Migration

1. Status Update T2S Migration Subgroup
2. Updates on Migration related Change Requests

Miscellaneous

1. Firm DCP Commitment
2. Market Readiness Reporting

Migration related Change Requests

Background for topics related to test and migration items

Most Change Requests (CRs) have been raised by the Migration Sub-group (MSG) and submitted to the Change Request Group (CRG). However, not all CRs have been assessed / accepted by the CRG

ECB ID ¹⁾	Criticality ²⁾	CR Title	Status	Potential customer impact
T2S 409 SYS	High	Support the migration of pending instructions with ISD in the past	Accepted and authorised at Steering level	No
		<ul style="list-style-type: none"> From a DCP point of view this Change Request provides a transparent solution No customer impact is expected as the cancellation procedure will not apply 		
T2S 411 SYS	High	Blocking and release of messages during migration weekend	Accepted and authorised at Steering level	Yes
		<ul style="list-style-type: none"> Customers acting in DCP mode will receive their messages after the verification of the CSDs Messages will be provided after the "Point of No Return" has been achieved 		
T2S 431 SYS	Critical	Queuing of incoming messages	Recommended to be rejected	Yes

- Outcome of MSG meeting Jan '14: ECB/4CB will investigate the feasibility for a message rejection mechanism (instead of queuing)
- Messages send by a DCP on the migration weekend will be rejected by T2S
- DCPs will have to resend these messages once T2S has entered the normal post-migration mode of operation

1) Details can be found in the ECB CRG documentation <http://www.ecb.europa.eu/paym/t2s/governance/tg/html/crg.en.html>

2) Criticality according to the ECB Change Request legal / business importance parameter

Questions from DCP Forum

Questions regarding Migration

9. Migration Weekend – and the role of the DCP's during the weekend (e.g. real time support)
10. Migration Weekend – Necessary Activities and timings after the “Point of No Return”. Potential issues to consider – is there sufficient time for DCP activities between Point of No Return and overnight batch.
11. Communication: DCPs to be promptly informed on progress during Migration, discuss method of information/updates sharing.
12. CSDs will consider measures to reduce number of pending transactions to be migrated into T2S (e.g. automatic cancellation of stale pending (unmatched) instructions and/or of failing transactions).
13. Windows for DCP migration: during each migration weekend and post-stabilization period until start of activities for the next migration wave.



SETTLING
WITHOUT
BORDERS

Agenda

Introduction

T2S User Testing

1. Status Update T2S User Testing Subgroup
 - a. T2S User Testing Calendar
 - b. E2E-Volume Testing
 - c. DCP Certification and Authorization
2. Updates on Testing related Change Requests

T2S Migration

1. Status Update T2S Migration Subgroup
2. Updates on Migration related Change Requests

Miscellaneous

1. Firm DCP Commitment
2. Market Readiness Reporting

Procedure DCP firm Commitment for discussion

Firm Confirmation DCP connectivity mode

- § An additional deadline ("DCP communication mode indication") will be defined by the Eurosystem after consultation within the User Testing Sub Group.
- § Extract from AG summary 18 November 2013: *"The next steps to achieve certification testing from the Eurosystem were reviewed, in particular the deadline of 2 March 2014 to provide a binding commitment for all entities that intend to be DCPs from the first wave for their securities and/or cash business in A2A."*
- § It is suggested by the DCP Forum Members to provide a firm commitment 12 months before the commencement of a particular wave community test period. The following dates can be derived:

	DCP Non-binding Commitment	DCP Firm Commitment	Community Test Commences*
Wave I	15 Oct 2013	02 Mar 2014	02 Mar 2015
Wave II	15 Oct 2013	21 Sep 2014	21 Sep 2015
Wave III	15 Oct 2013	15 Feb 2015	15 Feb 2016
Wave IV	15 Oct 2013	10 Oct 2015	10 Oct 2016



Workshop participants to discuss the necessity of a common generic template for the binding declaration to become a DCP coming along with an agreement on the procedure of the binding declaration

Proposal for discussion: binding declaration

DCP's binding declaration should comprise the following information

- § Name of institution (legal entity) which intends to become a DCP
- § Date when the institution intends to become active as a DCP
- § Indication whether DCP intends to use DCP and ICP channel parallel or exclusively
- § Name of CSD
- § NSP selected



SETTLING
WITHOUT
BORDERS

Agenda

Introduction

T2S User Testing

1. Status Update T2S User Testing Subgroup
 - a. T2S User Testing Calendar
 - b. E2E-Volume Testing
 - c. DCP Certification and Authorization
2. Updates on Testing related Change Requests

T2S Migration

1. Status Update T2S Migration Subgroup
2. Updates on Migration related Change Requests

Miscellaneous

1. Firm DCP Commitment
2. Market Readiness Reporting

Proposed DCP readiness status reporting procedure

- q Currently CSDs report on the steps they take to provide their community / DCPs the possibility to be ready
- q Interested DCP entities initiated the request to report to the ECB on their internal readiness
- q Although the exact scope of the status report is still to be defined, it is suggested that the DCPs report directly to the CSDs, where they intend to have a direct connectivity
- q CSDs will afterwards incorporate the status provided by the DCPs within their report
- q For discussion: Start of DCP readiness reporting

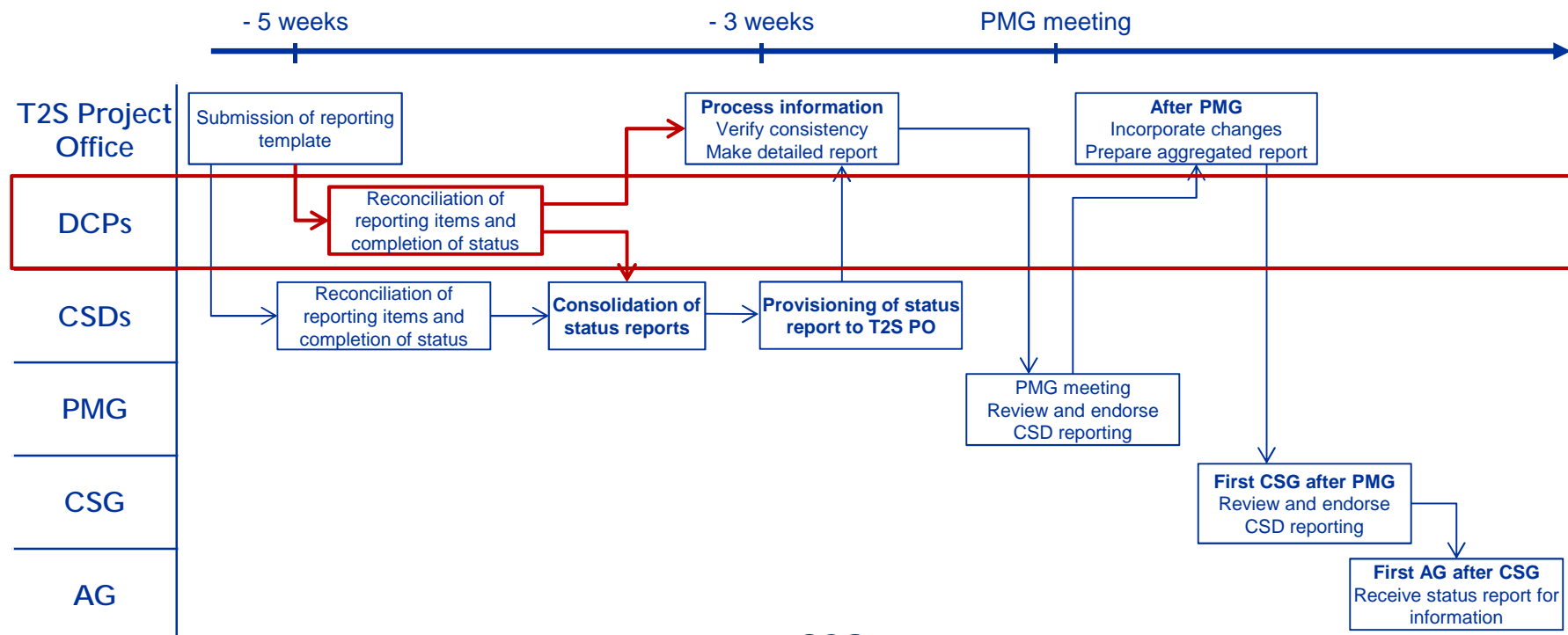

DCP Readiness Reporting Template

- CSDs have to report the readiness of their respective market towards ECB comprising both ICP and DCP readiness
- Reporting needs to reflect market specifics
- Nevertheless, the following information of a DCP are in general relevant for every DCP Readiness Reporting:
 - Project Management Status
 - Organizational Readiness
 - Formal and Legal Readiness
 - Technical Readiness
 - Functional Readiness



SETTLING
WITHOUT
BORDERS

Agenda

Appendix

Usage of T2S – Test Environments (1/2)

DRAFT - Not final

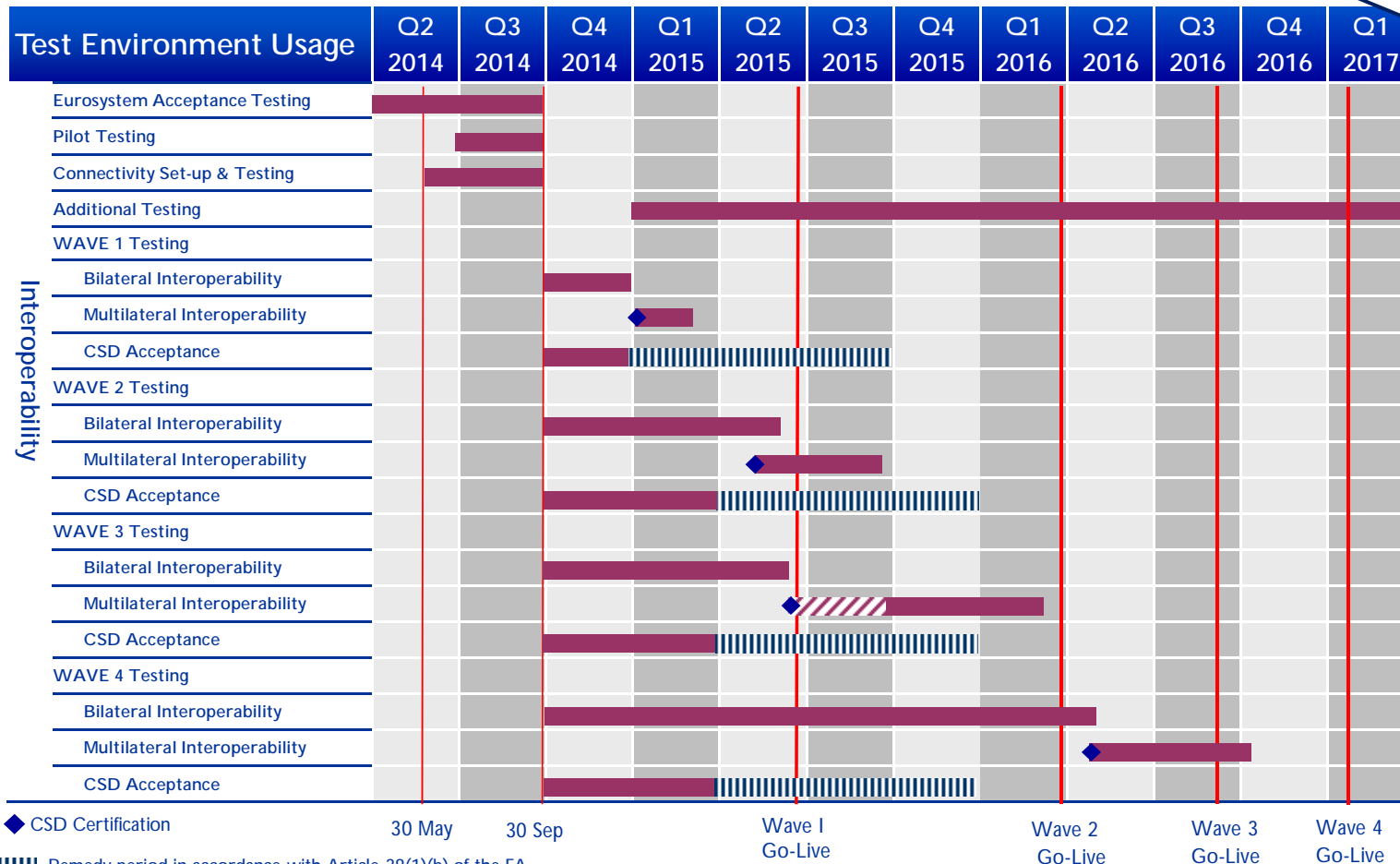

◆ CSD Certification 30 May 30 Sep Wave 1 Go-Live Wave 2 Go-Live Wave 3 Go-Live Wave 4 Go-Live

▤ Remedy period in accordance with Article 38(1)(b) of the FA

▨ Overlap of Wave 2 and Wave 3 Multilateral Interoperability testing stage

1) Source Terms of Reference - not final yet



SETTLING
WITHOUT
BORDERS

Usage of T2S – Test Environments (2/2)

DRAFT - Not final

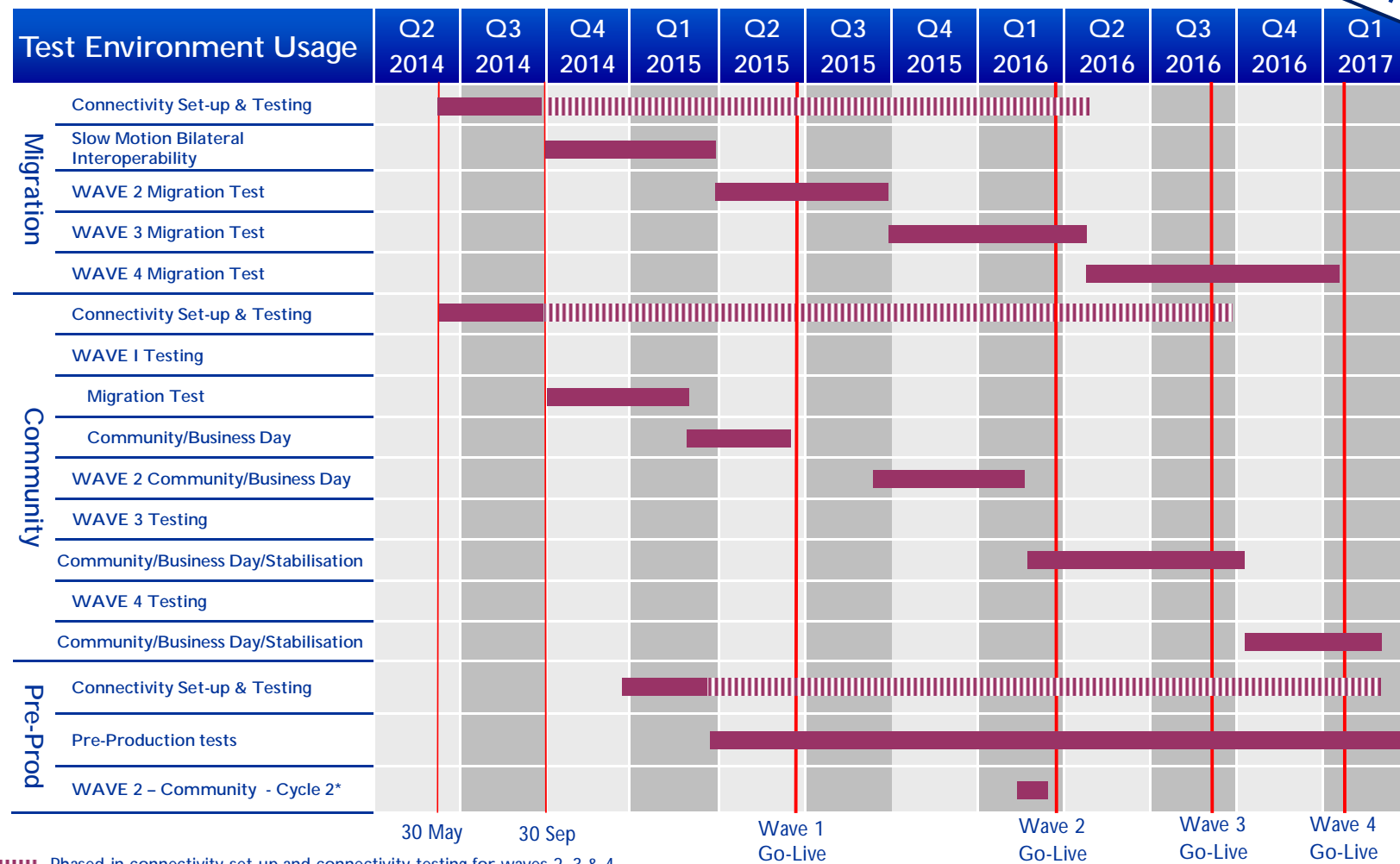

1) Source Terms of Reference - not final yet

Description of major User Testing Sub-group deliverables

Deliverable	Description
User Testing Calendar	The <i>User Testing Calendar</i> provides information on the organisation and availability of the test environments. It also presents the schedule planned for each of the test environments (e.g. slow motion or business day mode).
Migration Testing Approach and Plan	The Migration Testing Approach and Plan defines the testing organisation for migration processes and tools. It specifies the scheduling of different migration test scenarios for pre-migration and migration weekend processes (incl. contingency scenarios) per migration wave.
User Testing Reporting Framework	The <i>User Testing Reporting Framework</i> is to clarify the reporting procedures to be executed throughout the User Testing Execution Phase between different stakeholders. It covers the content definition, templates and the process to be followed. The CSD/CBs T2S Non-Compliance Notification, CSD/CBs T2S Compliance Notification, Eurosystem T2S Certification, User Testing Stage Report, CBs/CSDs Test Report and CBs/CSDs Certification Report are annexed to the User Testing Reporting Framework.
User Testing Terms of Reference (ToR)	The <i>UT ToR</i> outlines the principles for the organisation and structure of the testing stages. It focuses on the scope and content of each testing stage and presents the facilities for the test support and services provided for the execution of the User Testing.
User Testing Process Guide	The <i>User Testing Process Guide</i> presents the detailed processes for facilitating and organising the execution of User Testing. A <i>Registration Guide</i> for User Testing and the <i>Release Note</i> will be annexed to the User Testing Process Guide.